

HANDLES APPLICATION

Handles	Mini Handle	Finger Groove	PVC Door Pull Handle	V9 Handle	V10 Handle
Storages					
Pedestal	●	●		●	●
Hanging Cabinet				●	●
Lateral				●	●
Open Shelf					
Sliding Door			●		●
Swing Door	●	●		●	●

Encase  
(MFC & HPL)



All pictures are for illustration purposes. Colours, product dimension, specification as well as designs are subject to change without prior notice. Colours shown here may differ from the actual product.

Rev 2.0 December 2016

MALAYSIA  
Bristol Technologies Sdn Bhd  
Lot 5178 Balakong Jaya Light Industri,  
43300 Seri Kembangan, Selangor, Malaysia.  
Tel: +603 8962 3233  
Fax: +603 8962 6322  
Email: export@bristol.com.my  
Web: www.bristol.com.my  
www.facebook.com/bristolfurniture



## PEDESTAL

Length 350mm, Depth 500mm

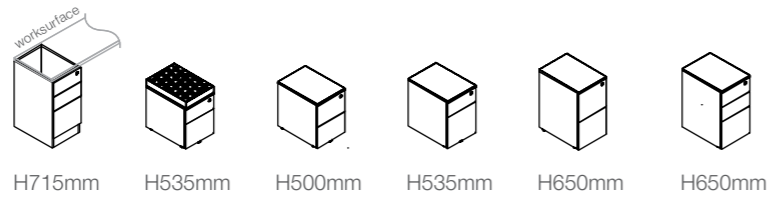

Length 410mm, Depth 500mm

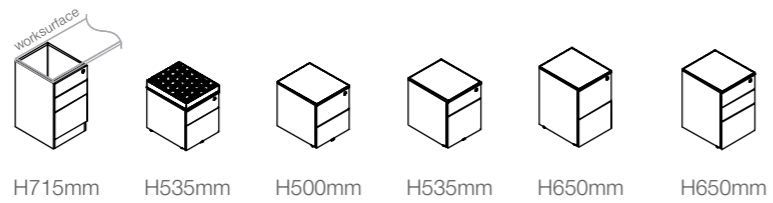

### FEATURES

- Available in MFC and HPL.
- Optional Mini handle, Finger groove, V9 or V10 handle.
- Lock included.
- Cushion seat only available for 535mm height.
- L350 pedestal does not come with pencil tray.

## OPEN SHELF CABINET

Length 600mm, Depth 450mm

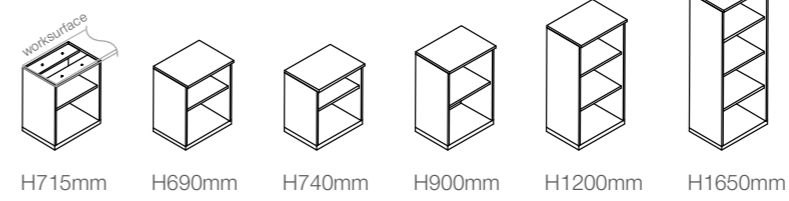

Length 750mm, Depth 450mm

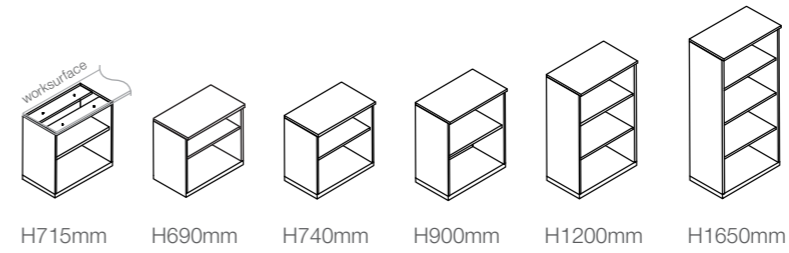

Length 900mm, Depth 450mm

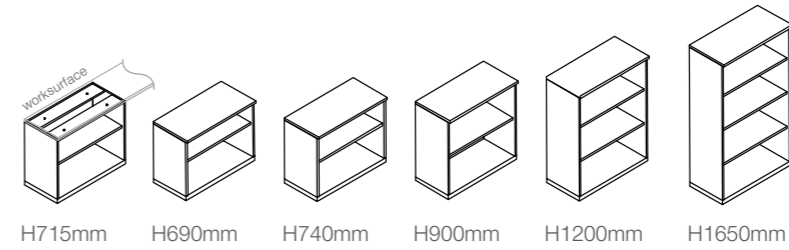

### FEATURES

- Available in MFC and HPL.
- Removable shelf.
- Suitable for binder storage.



## LATERAL FILING CABINET

Length 900mm, Depth 500mm

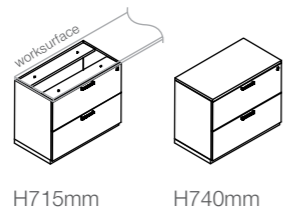

### FEATURES

- Available in MFC and HPL.
- Optional V9 or V10 handle.
- All drawers in metal and with anti-tilt system.
- Suitable for hanging files.

## SWING DOOR CABINET

Length 600mm, Depth 450mm

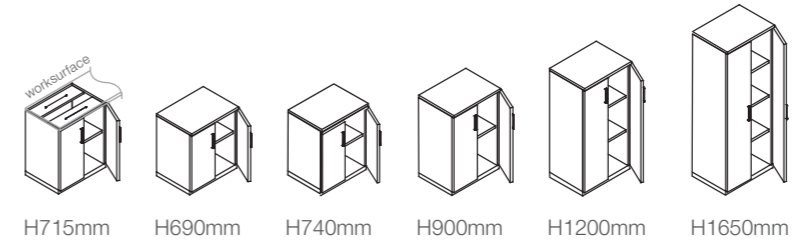

Length 750mm, Depth 450mm

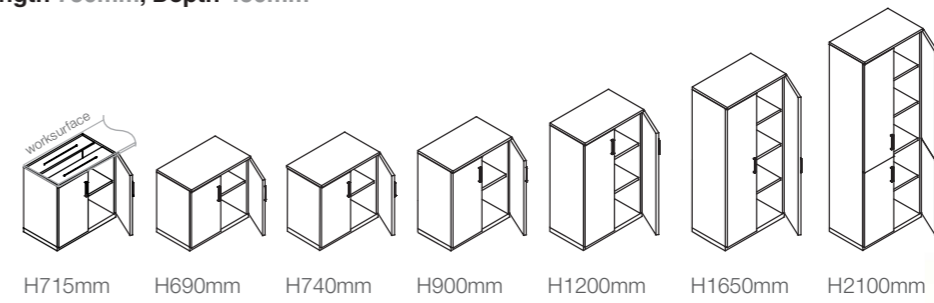

Length 900mm, Depth 450mm

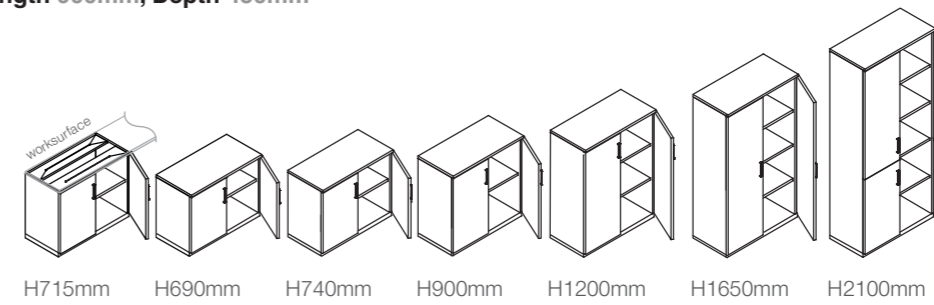

### FEATURES

- Available in MFC and HPL.
- Removable shelf.
- Optional Mini handle, Finger groove, or V9 handle.
- Lock included.



Finger groove is a simple yet effective pull style without the extra protruding handles.

## SLIDING DOOR CABINET

Length 600mm, Depth 450mm



H715mm

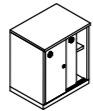

H690mm

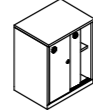

H740mm

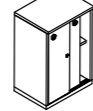

H900mm

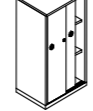

H1200mm

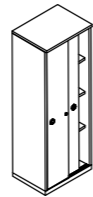

H1650mm

Length 750mm, Depth 450mm

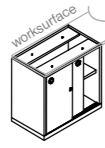

H715mm

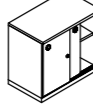

H690mm

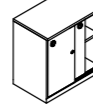

H740mm

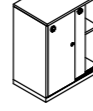

H900mm

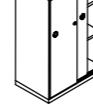

H1200mm

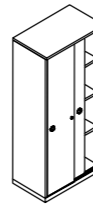

H1650mm

Length 900mm, Depth 450mm

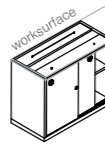

H715mm

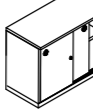

H690mm

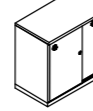

H740mm

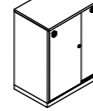

H900mm

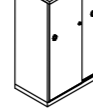

H1200mm

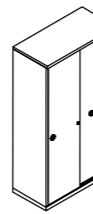

H1650mm

### FEATURES

- Available in MFC and HPL.
- Removable shelf.
- Optional PVC Door Pull or V10 handle.
- Lock included.

## HANGING CABINET

Depth 330mm, Height 450mm

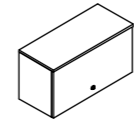

L750mm

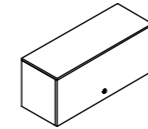

L900mm



### FEATURES

- Available in MFC and HPL.
- Able to upmount on all panel systems.
- Lock included.
- Optional V9 or V10 handle.

